



APV Paraflow Plate Heat Exchangers

For Chemical Process and Industrial Applications

Combat Corrosion and Ensure Efficiency for Even the Most Challenging Applications

From ultra-pure water to acid cooling to amine, APV combines the widest range of materials (both plate and gasket) and styles with an unmatched level of application experience to deliver optimal performance and maximum protection against process downtime.

Experienced APV engineers will work with you every step of the way from system design to start-up and beyond to ensure you get a solution customized for your specific process.

Advantages for Chemical and Industrial Applications

- Wide selection of gasket and plate materials to stand up to aggressive process fluids
- Ease of cleaning and inspection
- Semi-welded pairs and gasketed plates available
- Semi-welded pairs reduce the chance of leakage
- Flexible configurations can be adapted to meet your changing process needs
- Efficient operation
- High thermal efficiency saves money through reduction in required heat transfer area

- Low liquid hold-up improves start-up time and reduces operating fluid costs
- Achieves up to 97% heat recovery
- Eliminates complicated maintenance such as x-ray, ultrasonic and other non-destructive test procedures
- Corrosion resistant materials reduce inspection and maintenance while ensuring reliable operation
- No moving parts eliminates vibration and reduces maintenance
- Lower capital costs when compared to traditional shell and tube
- Compact design saves space
- Life cycle cost reduction
- Reduced fouling leads to higher thermal efficiency, reducing maintenance and operating costs

Applications

- Bauxite to alumina
- Chlorine alkaline
- Coke oven plant applications
- Soda ash
- Steel plant applications
- Mining applications
- Sulphuric acid
- Titanium dioxide/pigments
- Chloride process
- Zinc Phosphate

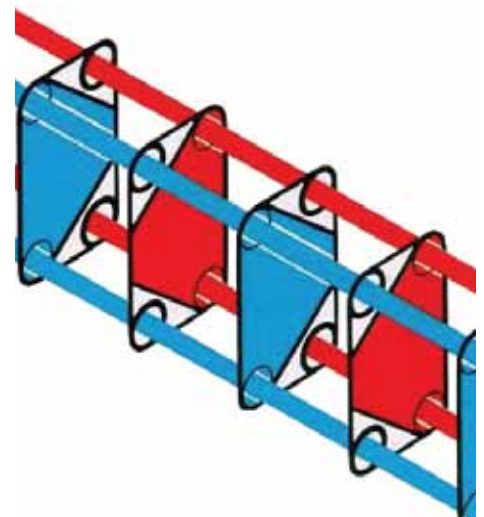

- Acrylic fibers
- Caprolactam (monomer for production of nylon 6)
- Desulphurization
- Ethylene glycol
- Ethylene oxide
- Formaldehyde resins
- Crude oil treatment
- Dehydration/desalting
- Gas compression
- Gas treatment

Efficiency and Reliability Come in All Sizes, Materials and Configurations

Applications Continued ...

- Gas/oil/water separation
- Oil and gas production
- Polyester
- Polyols
- Polystyrene
- PVC
- Alkylation
- MTBE
- Refinery
- Waste water treatment
- Viscose (viscose rayon is regenerated cellulose)
- Distillery pretreatment
- Fermentation
- Alcohol/ethanol
- Pulp and paper
- Beet and cane sugar
- Textiles
- Metal finishing
- Automotive

Materials

A wide variety of plate and gasket materials are available depending on your application. Below is a partial list of the more common gasket and plate materials:

Gasket Materials

- Paradur (fluoropolymer)
- Paracent (FDA compliant fluoropolymer)
- EPDM low halide
- Paraflor (high fluorine fluoropolymer)
- CSP (Hypalon)
- Silicone
- Paratemp (resin cured EPDM)
- Peroxide cured EPDM

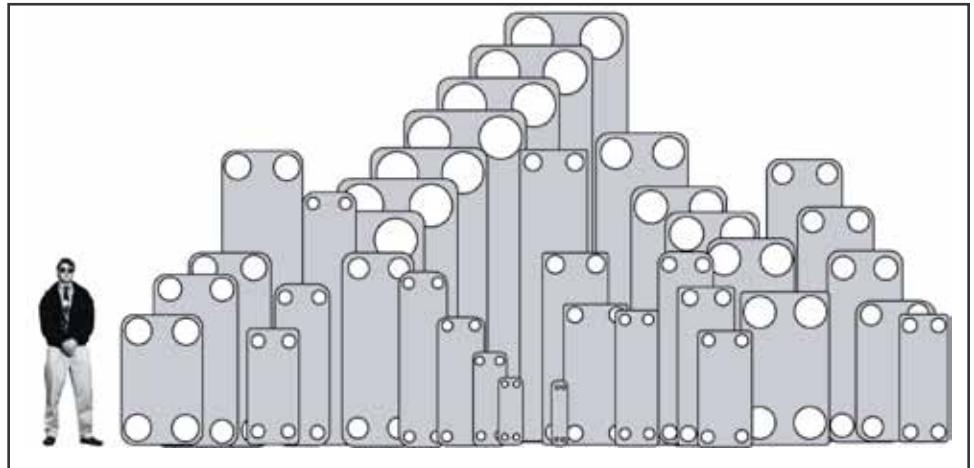

- Paramine
- Paranile (peroxy cured nitrile)
- Paracil (sulfur cured nitrile)
- Paraprene (Neoprene)
- Parator (hydrogenated nitrile)

Plate Materials

Austenetic Stainless

- Stainless steel (Gr. 304, 316, 317, 304L, 316L, 317 Ti)
- Alloy AL6XN
- Alloy 904L
- Alloy 27-7MO
- Alloy 254 SMO

Nickel Alloys

- Nickel 200
- Alloy G-30
- Alloy B-2
- Alloy C-22
- Alloy C-276
- Alloy C-2000
- Alloy 33

Other

- Titanium (Gr. 1)
- Titanium palladium (Gr. 7 and 11)

Start Benefiting Today

APV plate heat exchangers reduce maintenance and operating expenses while minimizing down time, delivering the benefits you need to improve the profitability of your process. APV's knowledgeable engineers will work with you every step of the way from system design to implementation and beyond, to ensure you get the optimal performance from your system. To learn more about how APV can help improve your profitability, call our information line at **1-800-207-2708**.

Basic Operation & Configurations

APV plate heat exchangers are one of the most versatile and cost-effective methods for the heating and/or cooling of fluids. The basic concept uses a corrugated heat transfer plate to separate the hot fluid from the cold and transfer the heat between the fluids.

The seal between the plates is established by a peripheral gasket which also separates the through ports and flow areas with a double barrier. The gasket either allows the fluid to flow down the plate channel or by-pass it to the adjacent plate channel as depicted in Figure 1.

APV plate heat exchangers can be used in a variety of different configurations.

One configuration is closed circuit cooling, where the dirty cooling medium such as sea, river, lake or tower water is isolated at the plate heat exchanger and clean treated water is continually recirculated through the process plant. This configuration, as shown in Figure 2, protects process equipment from the dirty cooling fluid.

One of the more common methods is direct cooling, where the product is cooled directly in the plate heat exchanger, as shown in Figure 3.

Another method is indirect cooling, where an intermediate fluid is used between the hot fluid and the cold fluid as shown in Figure 4. The purpose of indirect cooling is to guarantee that no cross-contamination between the hot and cold fluids will occur, even in an upset condition.

Fluid Distribution

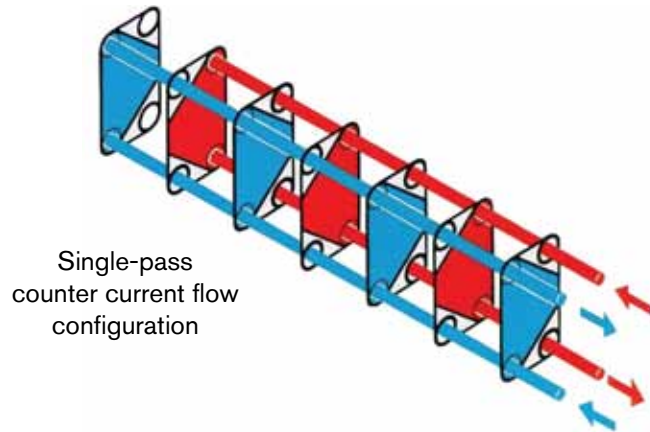

Figure 1

Closed Circuit Cooling System

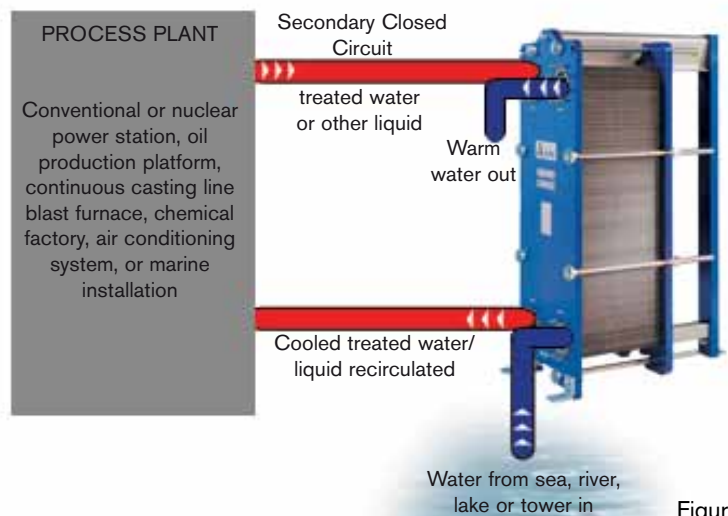

Figure 2

Direct Cooling

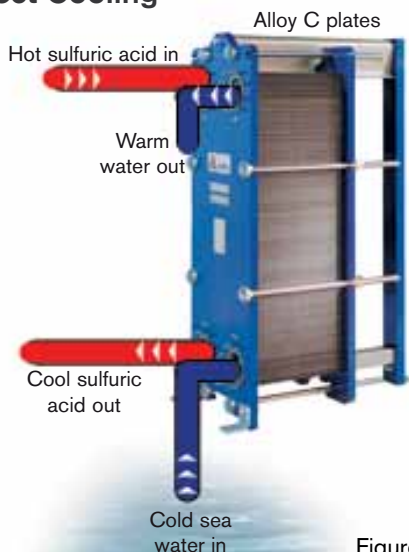

Figure 3

Indirect Cooling

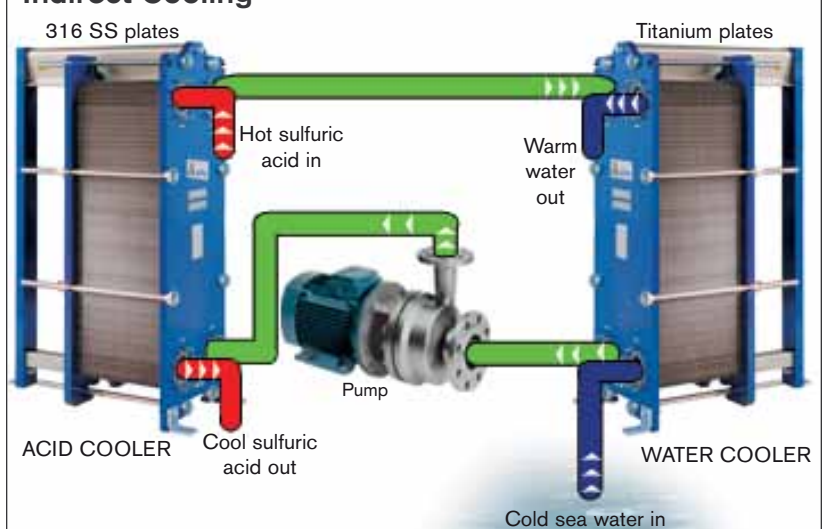
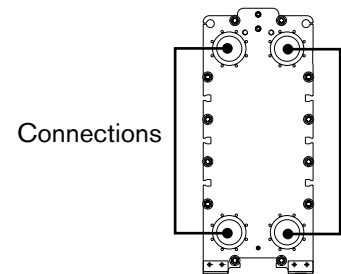
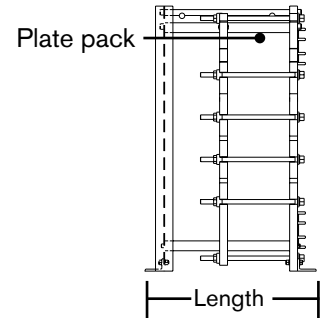

Figure 4

A Wide Range of Plate Heat Exchangers Chemical Process and Industrial Applications

Model Type	Connection Diameter (Inches)	Maximum US GPM	G	W	D	Standard Frame Length (Inches)**		Maximum Surface Area (ft ²)
						Minimum	Maximum	
APV - SR1	1.5	125	X			17	31	150
APV - SR2	2.0	200	X	X	X	20	59	650
APV - N35	3.0	460	X		X	16	98	1900
APV - Q030	4.0	800	X			40	104	1550
APV - Q055	4.0	800	X			40	104	2850
APV - Q080	4.0	800	X			40	104	4200
APV - SR6GH	4.0	800	X		X	40	104	1450
APV - SR6GL	4.0	800	X		X	40	104	2400
APV - SR6AG	4.0	800	X			40	104	4000
APV - SR6AA	4.0	800	X			40	104	4450
APV - LR4	4.0	800		X		24	66	1250
APV - R5*	4.0	800	X			37	220	3950
APV - ER5*	4.0	800	X			37	220	4000
APV - A055	6.0	1800	X			30	98	2700
APV - A085	6.0	1800	X			30	98	4150
APV - A145	6.0	1800	X			30	98	6900
APV - SR9*	8.0	3100	X			46	136	3200
APV - J060	8.0	3100	X			39	136	3950
APV - J092	8.0	3100	X			39	136	6250
APV - J185	8.0	3100	X			39	136	13800
APV - TR9GN	8.0	3100	X	X		46	110	5050
APV - TR9AV	8.0	3100	X	X		46	110	6700
APV - TR9AL	8.0	3100	X	X		46	110	8700
APV - B063	12.0	7000	X	X		46	197	6100
APV - B110	12.0	7000	X	X		46	197	10650
APV - B134	12.0	7000	X	X		46	197	12850
APV - B158	12.0	7000	X	X		46	197	15050
APV - B205	12.0	7000	X	X		46	197	15850
APV - Z155	16.0	11,000	X			147	265	12050
APV - Z195	16.0	11,000	X			147	265	15150
APV - Z230	16.0	11,000	X			147	265	18250
APV - Z270	16.0	11,000	X			147	265	21250
APV - Z310	16.0	11,000	X			147	265	24200
APV - Z350	16.0	11,000	X			147	246	24550
APV - Z390	16.0	11,000	X			147	246	27300
APV - Z430	16.0	11,000	X			137	236	29750
APV - S190	20.0	20,000	X			156	250	17000
APV - S280	20.0	20,000	X			156	250	25050
APV - S330	20.0	20,000	X			156	250	29400
APV - S380	20.0	20,000	X			156	250	33900

- * Wide Gap
- ** 150# ASME Frame Design as Basis
- G - Gasketed
- W - Welded Plate Pair
- D - Duo-Safety



SPX®



Your local contact:



APV, An SPX Brand
 105 CrossPoint Parkway
 Getzville, NY 14068
 Phone: (800)207-2708 Fax: (716)692-1715
 E-mail: answers.us@apv.com
 www.apv.com
 www.spxft.com

For more information about our worldwide locations, approvals, certifications, and local representatives, please visit www.apv.com.
 SPX Corporation reserves the right to incorporate our latest design and material changes without notice or obligation. Design features, materials of construction and dimensional data, as described in this bulletin, are provided for your information only and should not be relied upon unless confirmed in writing.